

# DATA SHEET

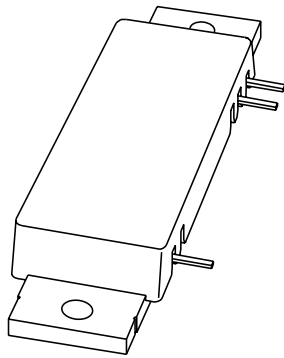

## **BGF844** GSM800 EDGE power module

Product specification  
Supersedes data of 2003 Feb 26

2003 Jun 06

# GSM800 EDGE power module

# BGF844

## FEATURES

- Typical GSM EDGE performance at a supply voltage of 26 V:
  - Output power = 2.5 W
  - Gain = 30 dB
  - Efficiency = 16%
  - ACPR < -65 dBc at 400 kHz
  - rms EVM < 0.4%
  - peak EVM < 1.2%
- Low distortion to a GSM EDGE signal
- Excellent 2-tone performance
- Low die temperature due to copper flange
- Integrated temperature compensated bias
- 50 Ω input/output impedance
- Flat gain over frequency band.

## APPLICATIONS

- Base station RF power amplifiers in the 869 to 894 MHz frequency range
- GSM, GSM EDGE, multi carrier applications
- Macrocell (driver stage) and Microcell (final stage).

## DESCRIPTION

23 W LDMOS power amplifier module for base station amplifier applications in the 869 to 894 MHz band.

## QUICK REFERENCE DATA

Typical RF performance at  $T_{mb} = 25\text{ }^{\circ}\text{C}$ .

MODE OF OPERATION	f (MHz)	V <sub>S</sub> (V)	P <sub>L</sub> (W)	G <sub>p</sub> (dB)	η (%)	ACPR (dBc)	rms EVM (%)
CW	869 to 894	26	23	29	50	–	–
GSM EDGE	869 to 894	26	2.5	30	16	-65 <sup>(1)</sup>	0.4

### Note

1. ACPR 400 kHz at 30 kHz resolution bandwidth.

## PINNING - SOT365C

PIN	DESCRIPTION
1	RF input
2	V <sub>S</sub>
3	RF output
Flange	ground

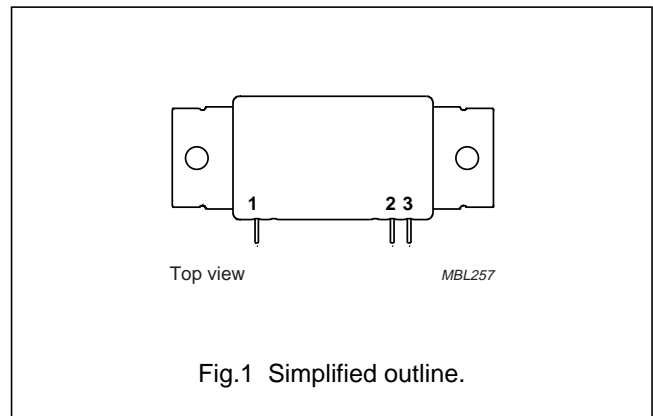

## GSM800 EDGE power module

## BGF844

## LIMITING VALUES

In accordance with the Absolute Maximum Rating System (IEC 60134).

SYMBOL	PARAMETER	MIN.	MAX.	UNIT
$V_S$	DC supply voltage	–	30	V
$P_D$	input drive power	–	100	mW
$P_L$	load power	–	27	W
$T_{stg}$	storage temperature	–30	+100	°C
$T_{mb}$	operating mounting base temperature	–20	+90	°C

## CHARACTERISTICS

$T_{mb} = 25\text{ °C}$ ;  $V_S = 26\text{ V}$ ;  $P_L = 2.5\text{ W}$ ;  $f = 869\text{ to }894\text{ MHz}$ ;  $Z_S = Z_L = 50\text{ }\Omega$ ; unless otherwise specified.

SYMBOL	PARAMETER	CONDITIONS	MIN.	TYP.	MAX.	UNIT
$I_{DQ}$	quiescent current (pin 2)	$P_D = 0\text{ mW}$	245	280	320	mA
$G_p$	power gain		28	30	32	dB
$\Delta G_{p\text{ freq}}$	gain flatness over frequency range		–	0.2	1	dB
$\Delta G_{p\text{ pwr}}$	gain flatness over power band	$P_L = 25\text{ mW}$ up to 2.5 W	–0.8	–0.2	+0.2	dB
$G_{OB}$	out of band gain	small signal, $P_D = 0\text{ dBm}$ ; $f < 869\text{ MHz}$ , $f > 894\text{ MHz}$	–	–	$G_{Pi\text{ max}} + 1$ note 1	dB
$V_{SWR_{in}}$	input VSWR		–	1.6 : 1	2 : 1	
$IMD_r$	reverse intermodulation	$f_i = f_c \pm 200\text{ kHz}$ ; $P_{\text{carrier}} = 2.5\text{ W}$ ; $P_{\text{interference}} = -40\text{ dBc}$ ;	–	–67	–64	dBc
$H_2$	second harmonic		–	–38	–34	dBc
$H_3$	third harmonic		–	–61	–58	dBc
	stability	$V_{SWR} \leq 3 : 1$ through all phases; $V_{S2} = 25\text{ to }28\text{ V}$	all spurious outputs more than 60 dB below desired signal			
	ruggedness	$V_{SWR} = 10 : 1$ through all phases; $P_L = 5\text{ W}$	no degradation in output power			

EDGE ( $P_L = 2.5\text{ W}$  average)

$\eta$	efficiency		13	16	–	%
SR200	spectral regrowth; EDGE GSM signal	200 kHz	–	–36	–35	dBc
SR400		400 kHz	–	–65	–63	dBc
SR600		600 kHz	–	–75	–73	dBc
$EVM_{rms}$	rms EDGE signal distortion		–	0.4	1.2	%
$EVM_M$	peak EDGE signal distortion		–	1.2	4	%

Intermodulation distortion ( $P_L = 2.5\text{ W}$  average)

$d_3$	third order intermodulation	carrier spacing = 200 kHz	–	–45	–	dBc
$d_5$	fifth order intermodulation		–	–52	–	dBc
$d_7$	seventh order intermodulation		–	–60	–	dBc

## Note

- $G_{Pi}$  is small signal in-band gain.

GSM800 EDGE power module

BGF844

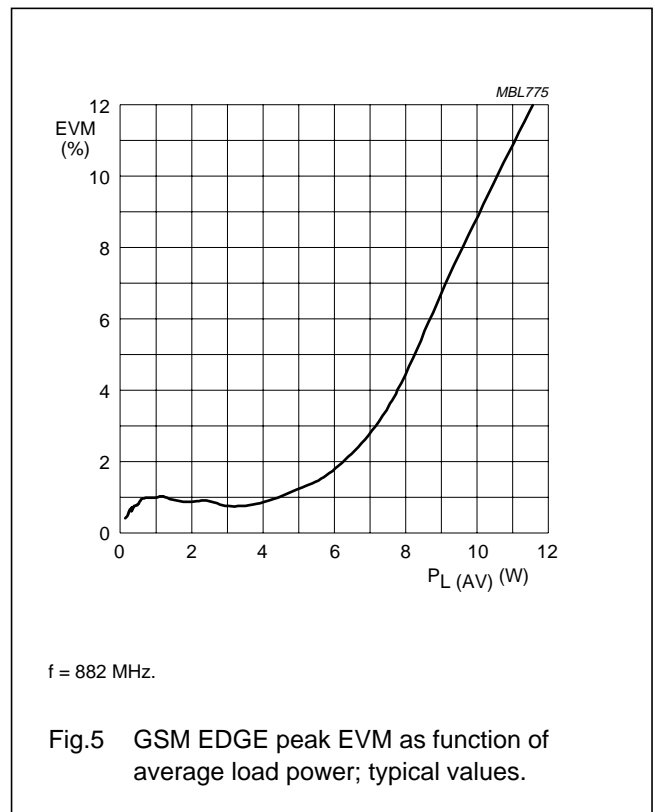
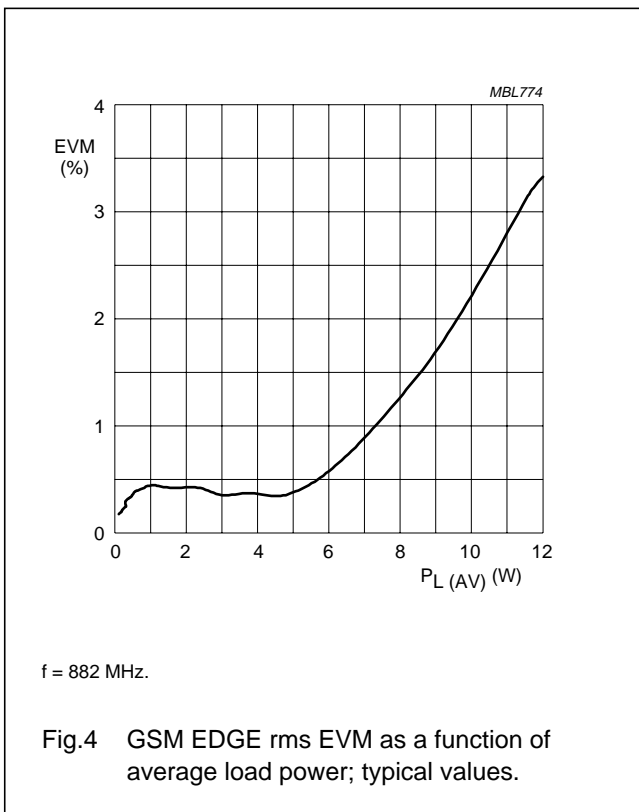
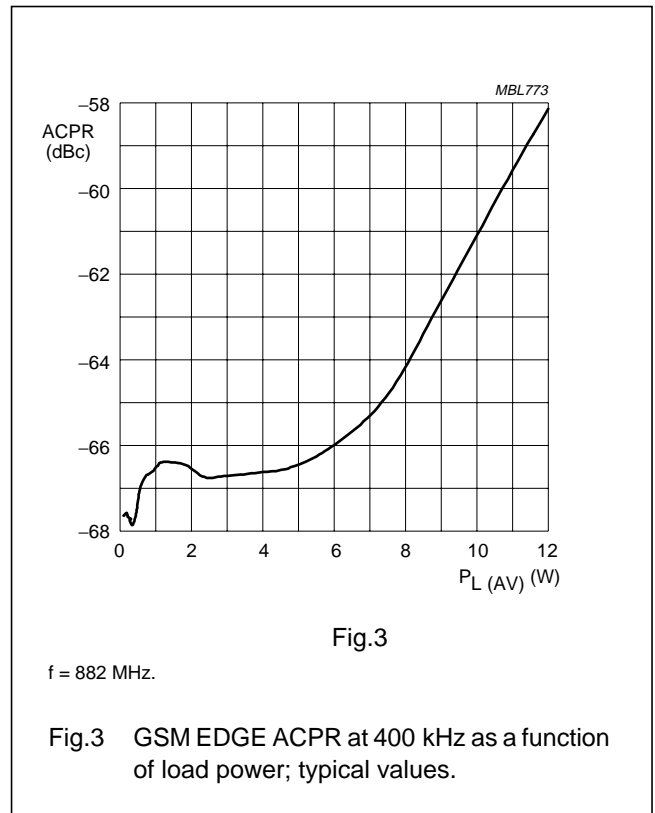
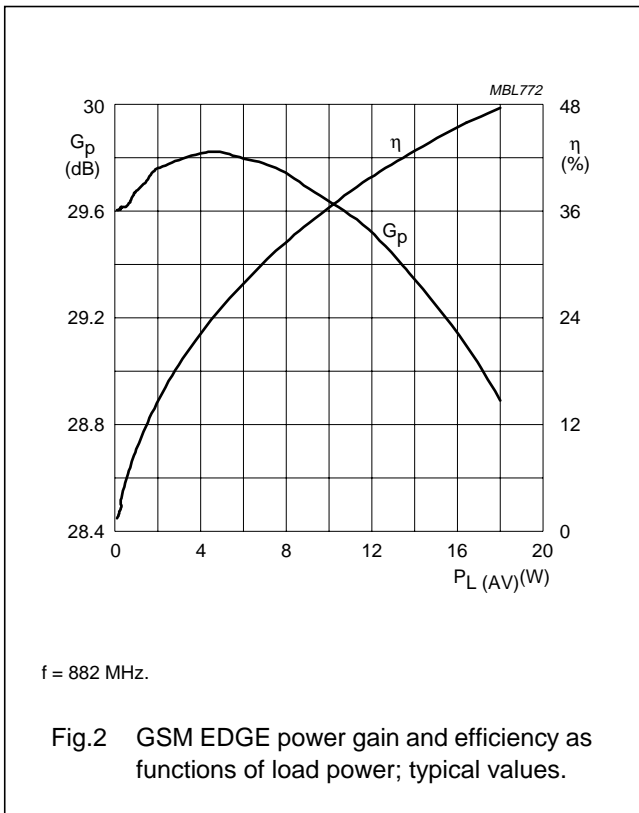

GSM800 EDGE power module

BGF844

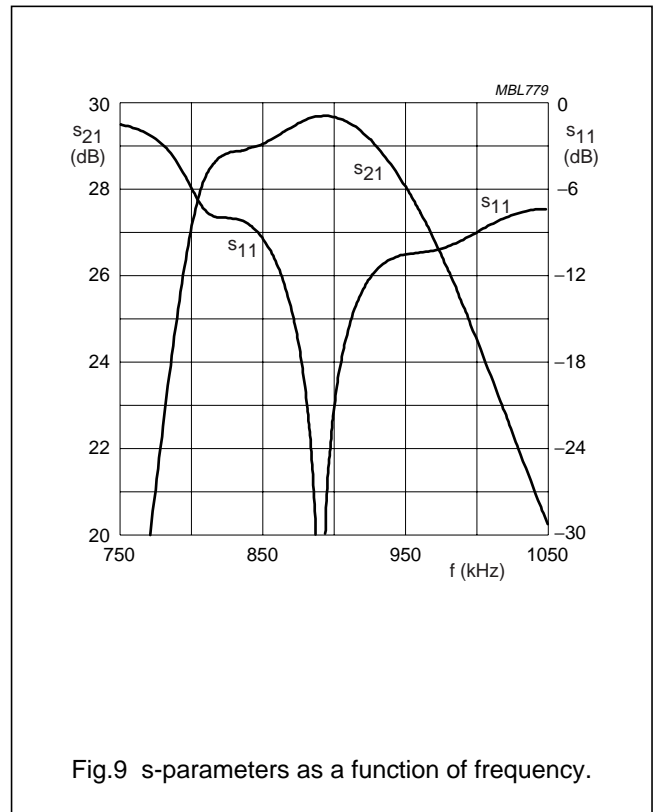
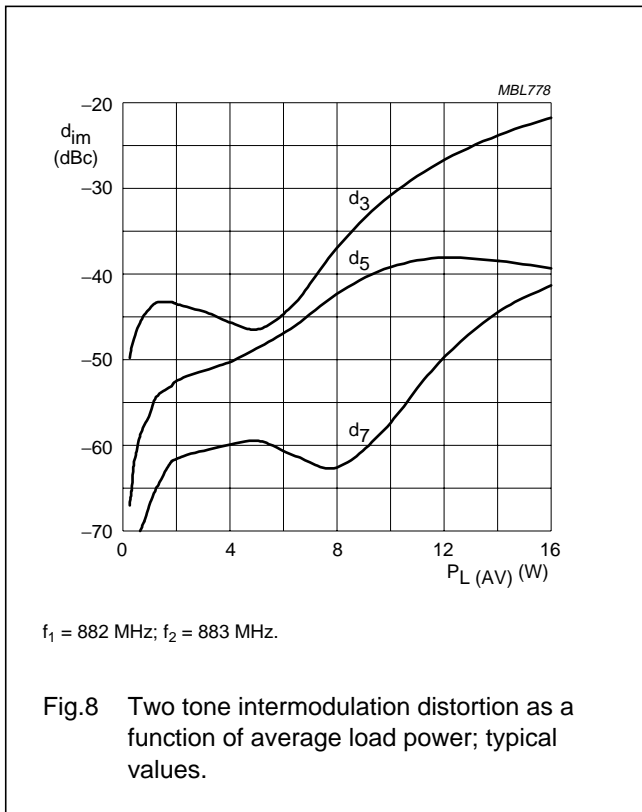
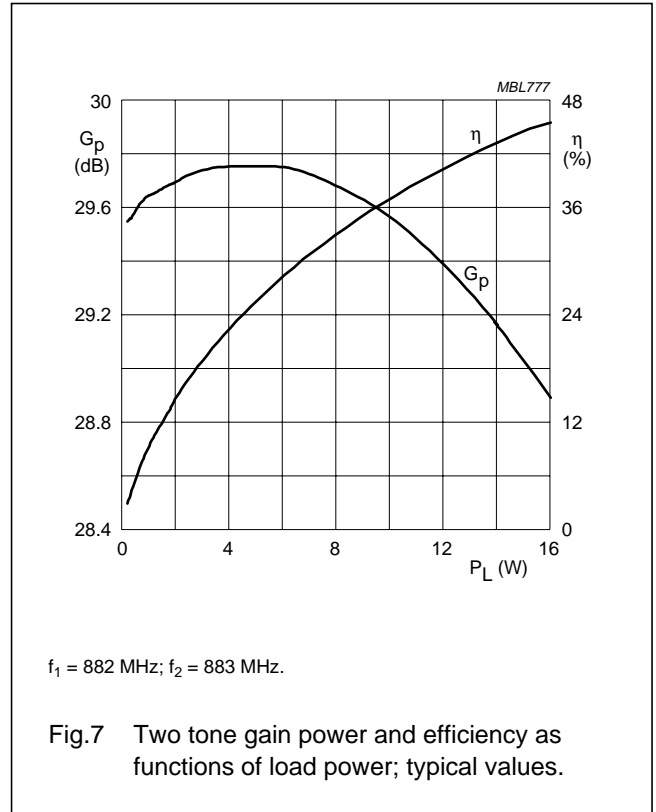
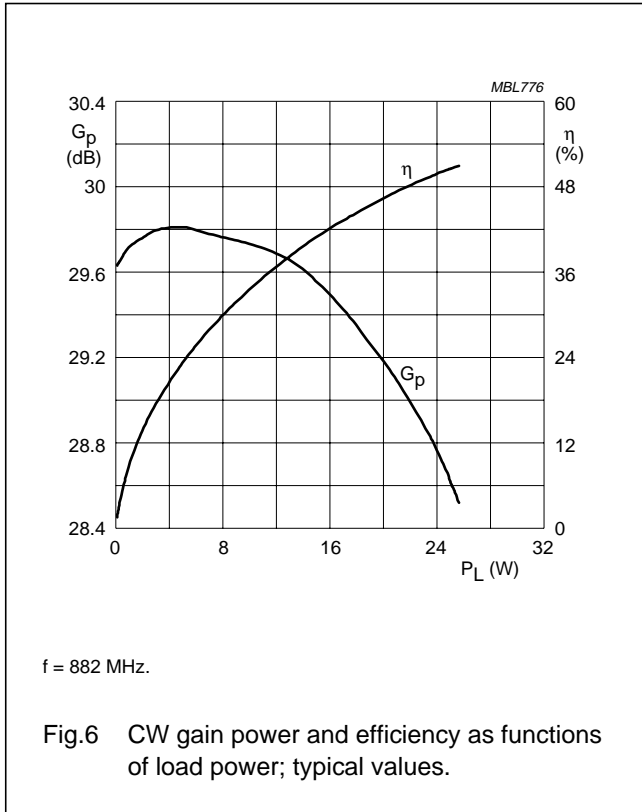

## GSM800 EDGE power module

BGF844

### MOUNTING RECOMMENDATIONS

#### General

LDMOST base station modules are manufactured with the dies directly mounted onto a copper flange. The matching and bias circuit components are mounted on a printed-circuit board (PCB), which is also soldered onto the copper flange. The dies and the PCB are encapsulated in a plastic cap, and pins extending from the module provide a means of electrical connection. This construction allows the module to withstand a limited amount of flexing, although bending of the module is to be avoided as much as possible. Mechanical stress can occur if the bottom surface of the module and the surface of the amplifier casing (external heatsink) are not mutually flat. This, therefore, should be a consideration when mounting the module in the amplifier. Another cause of mechanical stress can arise from thermal mismatch after soldering of the pins. Precautions should be taken during soldering, and efforts made to ensure a good thermal contact between the flange and the external heatsink.

#### External heatsink (amplifier casing)

The module should always be mounted on a heatsink with a low thermal resistance to keep the module temperature as low as possible. The mounting area of the heatsink should be flat and free from burrs and loose particles. We recommend a flatness for the mounting area of between 50  $\mu\text{m}$  concave and 50  $\mu\text{m}$  convex. The 50  $\mu\text{m}$  concave value is to ensure optimal thermal behaviour, while the 50  $\mu\text{m}$  convex value is intended to limit mechanical stress due to bending.

In order to ensure optimal thermal behaviour, the use of thermal compound is recommended when mounting the module onto the amplifier external heatsink.

The following recommended thermal compounds have a thermal conductivity of  $>0.5 \text{ W/mK}$ :

- WPS II (silicone-free) from Austerlitz-Electronics
- Comp. Trans. from KF
- 340 from Dow Corning
- Trans-Heat from E. Friis-Mikkelsen.

The use of thermal pads instead of thermal compound is not recommended as the pads may not maintain a uniform flatness over a period of time.

#### Mounting

##### PREPARATION

Ensure that the surface finishes are free from burrs, dirt and grease.

##### CAUTION

During the following procedures ESD precautions should be taken to protect the device from electrostatic damage.

##### PROCEDURE

1. Apply a thin, evenly spread layer of thermal compound to the module flange bottom surface. Excessive use of thermal compound may result in increased thermal resistance and possible bending of the of the flange. Too little thermal compound will result in an increase in thermal resistance.
2. Take care that there is some space between the cap and the PCB. Bring the module into contact with the external heatsink casing, ensuring that there is sufficient space for excessive thermal compound to escape.
3. Carefully align the module with the heatsink casing mounting holes, and secure with two 3 mm bolts and two flat washers. Initially tighten the bolts to "finger tight" (approximately 0.05 Nm). Using a torque wrench, tighten each bolt in alternating steps to a final torque of 0.4 Nm.
4. After the module is secured to the casing, the module leads may be soldered to the PCB. The leads are for electrical connection only, and should not be used to support the module at any time in the assembly process.

A soldering iron may be used up to a temperature of 250  $^{\circ}\text{C}$  for a maximum of 10 seconds. Avoid contact between the soldering iron and the plastic cap.

#### Electrical connections

The main ground path of all modules is via the flange. It is therefore important that the flange is well grounded and that return paths are kept as short as possible.

An incorrectly grounded flange can result in a loss of output power or in oscillation.

The RF input and output of the module are designed for 50  $\Omega$  connections.

#### Incoming inspection

When incoming inspection is performed, use a properly designed test fixture to avoid excessive mechanical stress and to ensure optimal RF performance. Philips can deliver dedicated test fixtures on request.

## GSM800 EDGE power module

BGF844

## APPLICATION INFORMATION

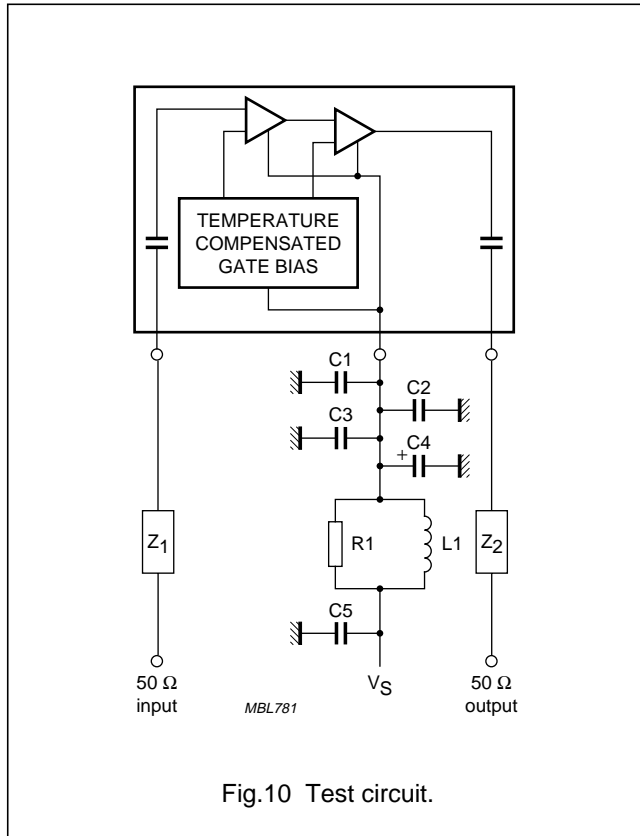

## List of components (see Figs 10 and 11)

COMPONENT	DESCRIPTION	VALUE	CATALOGUE NUMBER
C1, C3	multilayer X7R ceramic chip capacitor	100 nF; 50 V	
C2, C5	tantalum SMD capacitor	10 $\mu$ F; 35 V	
C4	electrolytic capacitor	100 $\mu$ F; 35 V	
L1	grade 4S2 Ferroxcube bead		4330 030 36300
R1	metal film resistor	10 $\Omega$ ; 0.4 W	2322 195 13109
Z1, Z2	stripline; note 1	50 $\Omega$	

## Note

1. The striplines are on a double copper-clad printed-circuit board (RO5880) with  $\epsilon_r = 2.2$  and thickness = 0.79 mm.

GSM800 EDGE power module

BGF844

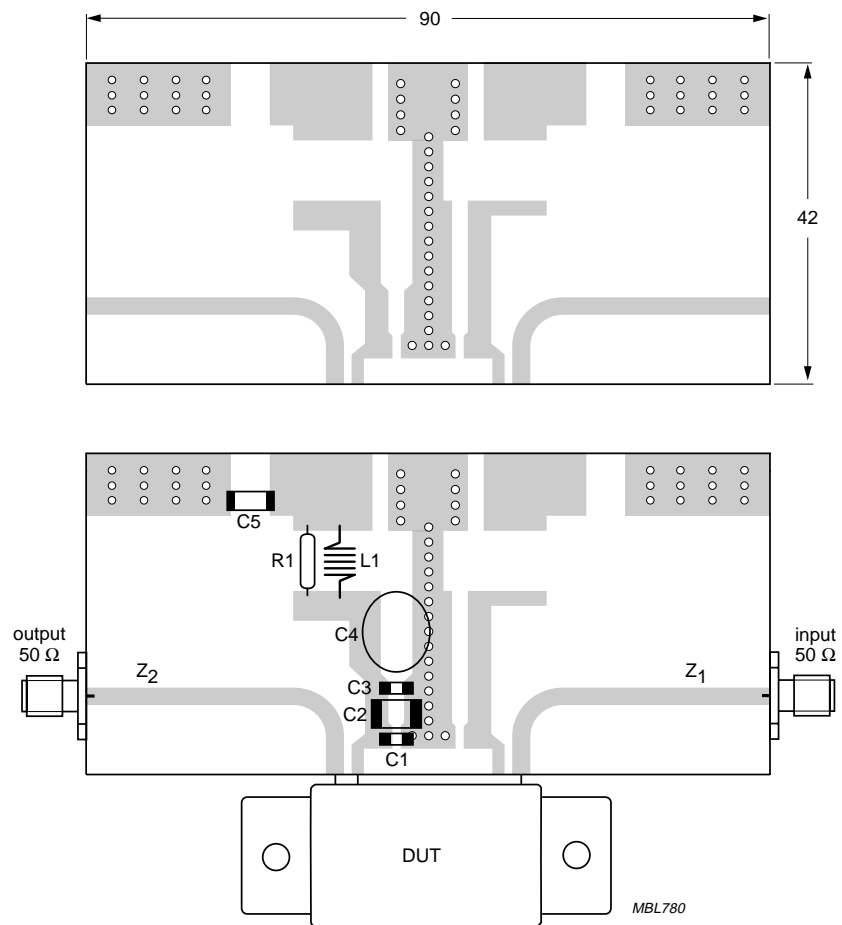

Dimensions in mm.

Fig.11 Printed-circuit board and component layout.



GSM800 EDGE power module

BGF844

PACKAGE OUTLINE

Plastic rectangular single-ended flat package; flange mounted; 2 mounting holes; 3 in-line leads SOT365C

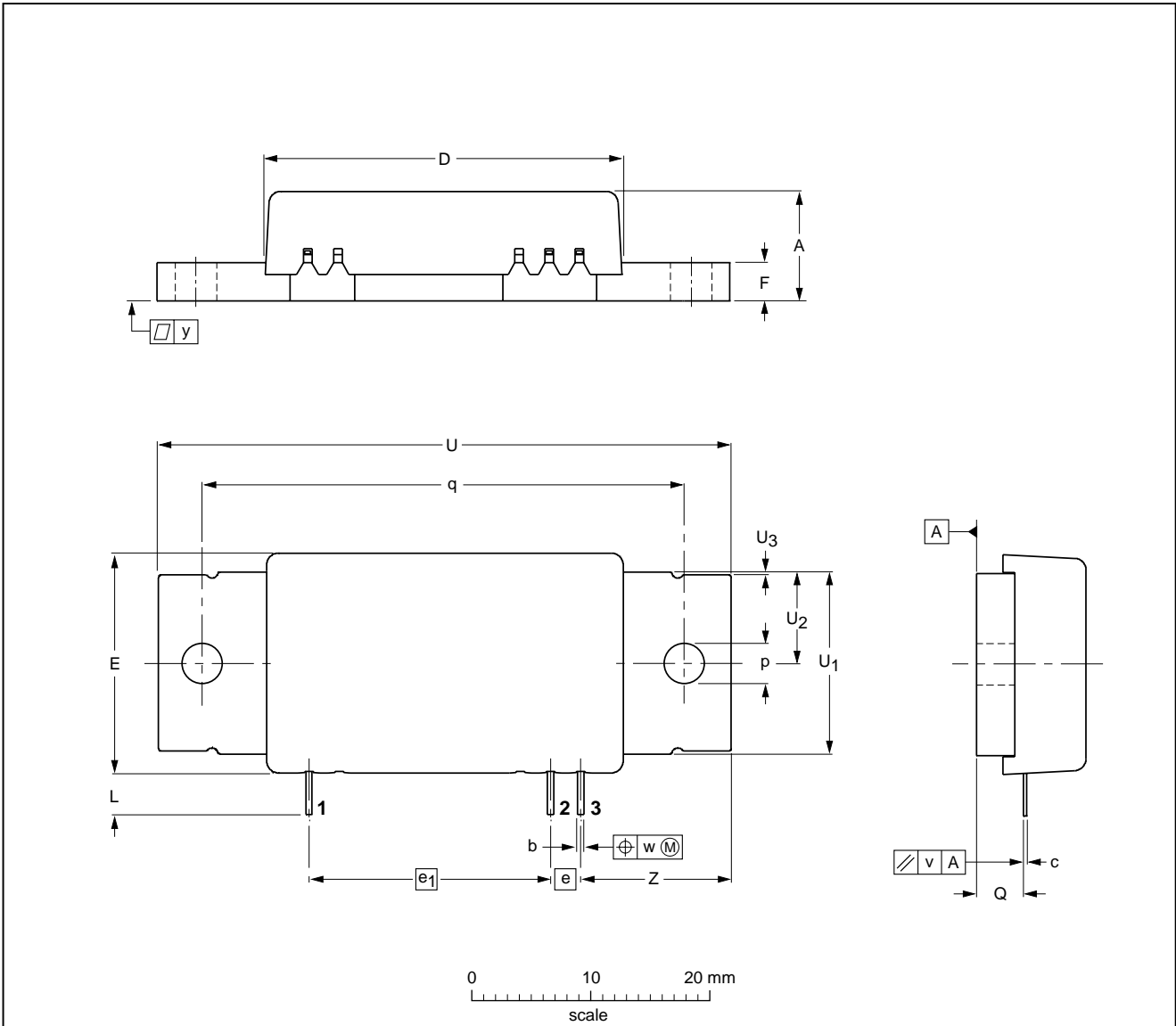

DIMENSIONS (mm are the original dimensions)

UNIT	A	b	c	D	E	e	e <sub>1</sub>	F	L	p	Q	q	U	U <sub>1</sub>	U <sub>2</sub>	U <sub>3</sub>	v	w	y	Z
mm	9.5 9.0	0.56 0.46	0.3 0.2	30.1 29.9	18.6 18.4	2.54	20.32	3.3 3.1	3.7 3.3	3.55 3.45	4.0 3.8	41.75 41.65	48.4 48.0	15.4 15.2	7.75 7.55	1.1 0.0	0.3	0.25	0.1	12.8 12.6

OUTLINE VERSION	REFERENCES			EUROPEAN PROJECTION	ISSUE DATE
	IEC	JEDEC	JEITA		
SOT365C					01-06-06 02-11-13

## GSM800 EDGE power module

BGF844

## DATA SHEET STATUS

LEVEL	DATA SHEET STATUS <sup>(1)</sup>	PRODUCT STATUS <sup>(2)(3)</sup>	DEFINITION
I	Objective data	Development	This data sheet contains data from the objective specification for product development. Philips Semiconductors reserves the right to change the specification in any manner without notice.
II	Preliminary data	Qualification	This data sheet contains data from the preliminary specification. Supplementary data will be published at a later date. Philips Semiconductors reserves the right to change the specification without notice, in order to improve the design and supply the best possible product.
III	Product data	Production	This data sheet contains data from the product specification. Philips Semiconductors reserves the right to make changes at any time in order to improve the design, manufacturing and supply. Relevant changes will be communicated via a Customer Product/Process Change Notification (CPCN).

## Notes

1. Please consult the most recently issued data sheet before initiating or completing a design.
2. The product status of the device(s) described in this data sheet may have changed since this data sheet was published. The latest information is available on the Internet at URL <http://www.semiconductors.philips.com>.
3. For data sheets describing multiple type numbers, the highest-level product status determines the data sheet status.

## DEFINITIONS

**Short-form specification** — The data in a short-form specification is extracted from a full data sheet with the same type number and title. For detailed information see the relevant data sheet or data handbook.

**Limiting values definition** — Limiting values given are in accordance with the Absolute Maximum Rating System (IEC 60134). Stress above one or more of the limiting values may cause permanent damage to the device. These are stress ratings only and operation of the device at these or at any other conditions above those given in the Characteristics sections of the specification is not implied. Exposure to limiting values for extended periods may affect device reliability.

**Application information** — Applications that are described herein for any of these products are for illustrative purposes only. Philips Semiconductors make no representation or warranty that such applications will be suitable for the specified use without further testing or modification.

## DISCLAIMERS

**Life support applications** — These products are not designed for use in life support appliances, devices, or systems where malfunction of these products can reasonably be expected to result in personal injury. Philips Semiconductors customers using or selling these products for use in such applications do so at their own risk and agree to fully indemnify Philips Semiconductors for any damages resulting from such application.

**Right to make changes** — Philips Semiconductors reserves the right to make changes in the products - including circuits, standard cells, and/or software - described or contained herein in order to improve design and/or performance. When the product is in full production (status 'Production'), relevant changes will be communicated via a Customer Product/Process Change Notification (CPCN). Philips Semiconductors assumes no responsibility or liability for the use of any of these products, conveys no licence or title under any patent, copyright, or mask work right to these products, and makes no representations or warranties that these products are free from patent, copyright, or mask work right infringement, unless otherwise specified.

GSM800 EDGE power module

BGF844

---

**NOTES**

# ***Philips Semiconductors – a worldwide company***

## **Contact information**

For additional information please visit <http://www.semiconductors.philips.com>. Fax: +31 40 27 24825

For sales offices addresses send e-mail to: [sales.addresses@www.semiconductors.philips.com](mailto:sales.addresses@www.semiconductors.philips.com).

© Koninklijke Philips Electronics N.V. 2003

SCA75

All rights are reserved. Reproduction in whole or in part is prohibited without the prior written consent of the copyright owner.

The information presented in this document does not form part of any quotation or contract, is believed to be accurate and reliable and may be changed without notice. No liability will be accepted by the publisher for any consequence of its use. Publication thereof does not convey nor imply any license under patent- or other industrial or intellectual property rights.

Printed in The Netherlands

613524/07/pp12

Date of release: 2003 Jun 06

Document order number: 9397 750 11507

*Let's make things better.*

**Philips  
Semiconductors**



**PHILIPS**